

ERSCMG0600G Collar

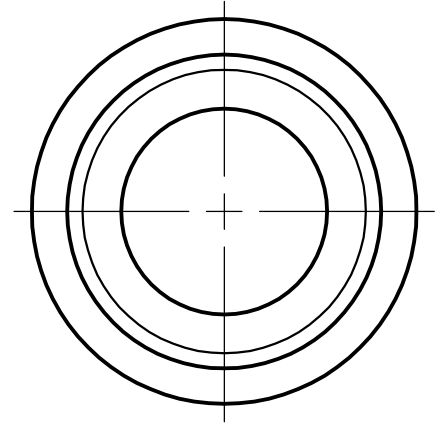
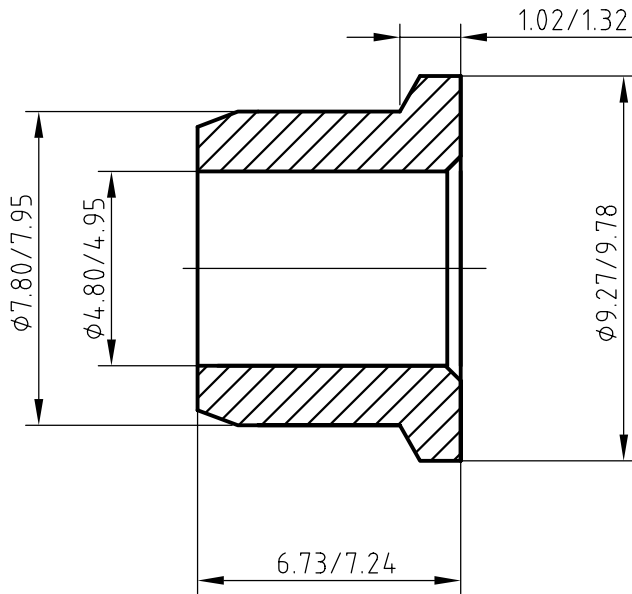

Technical Requirements

Material: Low Carbon Steel
Smooth Surface: Without Burr

Heat Treatment: Annealing
Surface Treatment: CR3+ zinc clear and waxed