

SECURITY LATCH UM1268 SERIES

UM1268-20/22



Details

The UM1268 security latch offers a basic product platform that is found in common use in secure enclosures. Manufactured in stainless steel to provide a vandal resistant lock to IP65 level.

- Stainless Steel 304
- 12mm bayonet insert
- Chamfered face provides resistance to vandal attack
- Rated to IP65

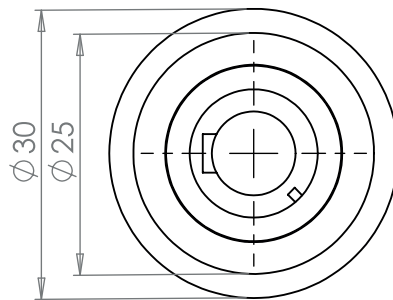
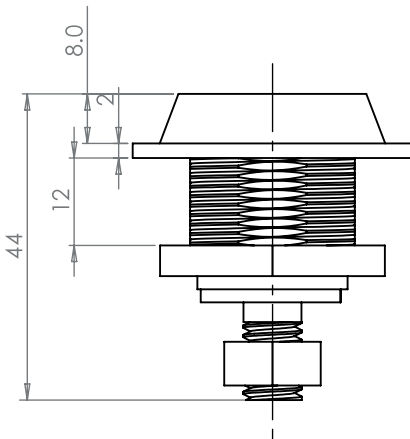

Supply Features

Each security latch includes:

- 1 x hsg seal
- 1 x large washer
- 1 x hsg nuts
- 1 x hex lock nut

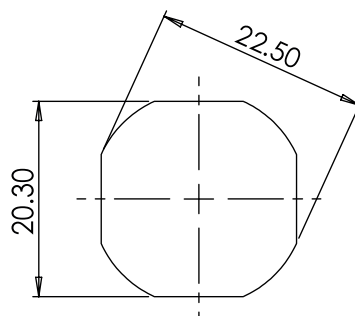
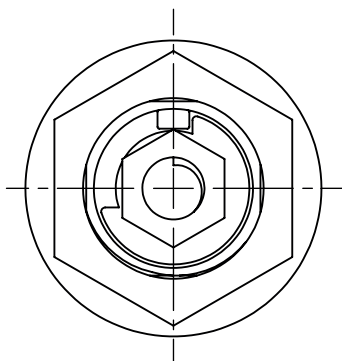

Ordering information:
Keys ordered separately